

Room thermostat with large LCD

RDH100..



Non-programmable, for heating systems

- 2-position or PID control to switch on/off heating systems
- Large LCD
- Minimum and maximum setpoint limitation
- Battery-powered: 2 x alkaline batteries type AA, 1.5 V

The RDH 100 is used to control the room temperature in heating systems.

Typical applications:

- Homes
- Residential buildings
- Schools
- Offices

The device is used together with the following equipment:

- Thermal valves or zone valves
- Combi boilers
- Gas or oil burners
- Pumps

Functions

Temperature control

RDH100 offers both 2-position and PID intelligent learning temperature control, configurable via parameter P01 (control behaviour).

2-position control algorithm is to switch on and off the heating system within a switching differential (SD) as per difference between setpoint setting and measured room temperature.

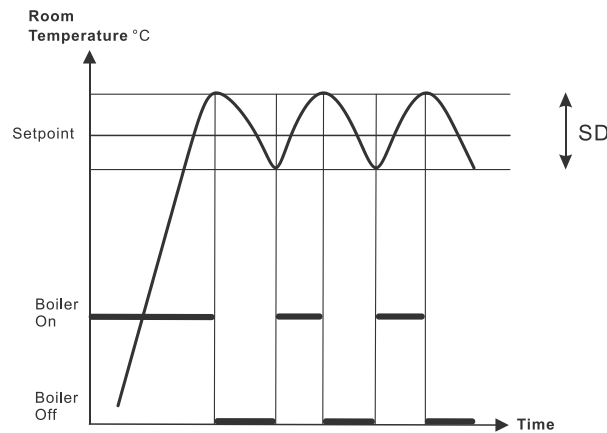

PID intelligent learning control algorithm periodically switches on and off the heating system. The period time (T) and pulse length (P) of the control signal (PWM) are determined by the setpoint and the measured room temperature.

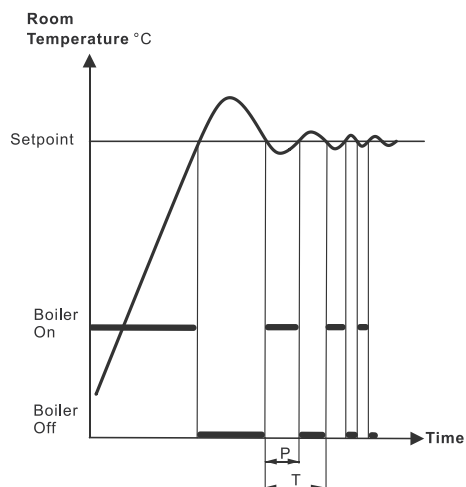

In general, PID control provides more comfort and is more energy efficient than 2-position control.

Control behaviour (P01)

The factory setting for control is “PID slow”, ideal for most heating systems. Optimum control can be selected if control does not provide the desired result:

2-position, 1 K

2-position controller with 1 [K] switching hysteresis

- For systems with small capacity that appear slow
- For applications requiring extended runtimes or where frequent switching causes problems
- For difficult control loops where hunting may result

Typical applications:

- Dry floor heating systems
- Heat pumps
- Electric heating with contactors

2-position, 0.5 K

- 2-position controller with 0.5 [K] switching hysteresis.
- For general control situations. Provides better comfort than 1 [K] switching hysteresis.
- Can also be used for difficult control situations.

PID slow

PID control behaviour for slow heating systems that require longer minimum On times and a limited number of switching cycles per hour.

Typical applications:

- Wet floor heating systems, oil fired boilers
- Can also be used for all other types of heating applications. (Alternative setting)

Minimum switch on/off time	> 4 minutes
Minimum period	Approximately 12 minutes

PID fast

PID control behaviour for fast heating systems that tolerate a high number of switching cycles.

Typical applications:

- Electric heaters with current valve
- Gas boilers
- Fast thermal actuators

Minimum switch on/off time	> 1 minute
Minimum period	Approximately 6 minutes



⚠ WARNING

Do not use PID fast for oil boilers or electric mechanical actuators!

Backup

When removing the batteries, the setpoints and information required for operating mode changeover are retained for max. 2 minutes.

Parameter list

Parameter	Description	Factory setting	Setting range	Remark
P01	Control behavior	PID slow (4)	0 = 2P, 1.0 K 1 = 2P, 0.5 K 2 = PID fast 4 = PID slow	
P02	Maximum temperature range	30 °C	P03...30 °C	Limit of comfort and economy setpoint
P03	Minimum temperature range	5 °C	5 °C...P02	Limit of comfort and economy setpoint
End	Exit parameter setting			

Parameter setting

The parameter setting remains in non-volatile memory and is not erased when the battery is removed. The reset function on the rear of the thermostat reloads the factory settings.



SIEMENS
RDH100 | DC3V 2xAAA
LE: 1...2 5021A
AC24 230V
52Hz
Country of Origin: China | 1.40 3920
Nemetschek ZH/RS/MS/US/CH/5300 Zuo
Alkaline Batteries

RESET

 5 s

Parameter setting mode

1. Press RESET on the rear for 5 seconds until “P01” appears.
Note: Pressing the button longer than 10 seconds resets the thermostat.
2. Press RESET again and the parameter value on second line flashes and is ready for adjustment.
3. Adjust the parameter using setting knob.
4. Press RESET once to confirm the setting.
5. Rotate the setting knob clockwise to next parameter and repeat steps 2 to 4.
6. Exit the parameter setting mode by rotating the setting knob clockwise to “End” and pressing the RESET button once.



P01

4

End

Note: The thermostat automatically exits parameter setting mode one minute after the last action.

Equipment combinations

Description		Product number	Data sheet *)
Electrothermal actuator (for radiator valves)		STA23..	4884
Electrothermal actuator (for small valves 2.5mm)		STP23..	4884
Electromotoric actuator		SFA21..	4863

*) The documents can be downloaded from <http://siemens.com/bt/download>.

Display

The digital display shows the current room temperature and the comfort temperature setpoint. When the heating output is active, the triangle symbol is displayed.

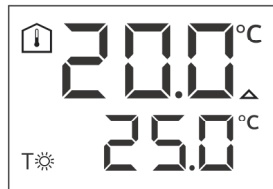

Ordering

When ordering, specify both name and product number, e.g. room temperature controller RDH100.

Order valves and actuators as separate items.

Mechanical design

The device consists of 3 parts:

- Plastic housing with digital display containing the electronics, operating elements, and built-in room temperature sensor
- Baseplate (mounting base)
- Battery compartment

The housing engages in the baseplate and snaps on. The baseplate carries the screw terminals. There is a reset button on the rear of the device.

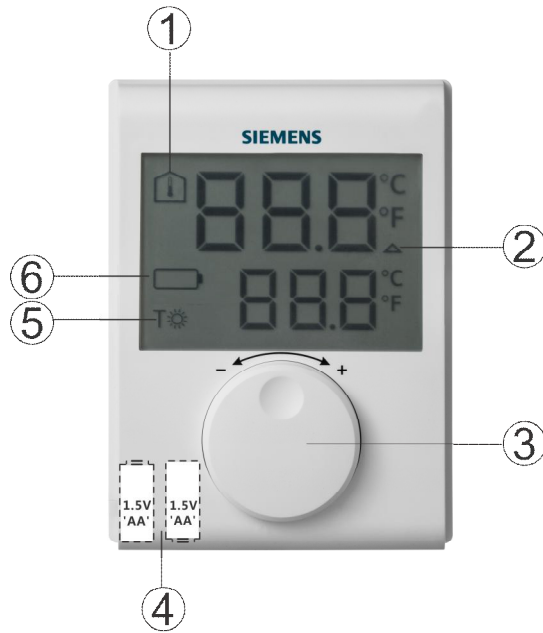

Elements	1		Display of the room temperature in °C / °F
	2		Indicates a request for heating
	3		Temperature setting knob
	4		Battery compartment
	5		Comfort temperature setpoint
	6		Indicates low battery power; replace batteries

Product documentation

Topic	Title	Document ID:
Operating	Operating instructions	A6V101035984
Installation	Mounting instructions	A6V10974417
CE declaration		A6V101123363

Related documents such as CE declaration, etc., can be downloaded at the following address:
<http://siemens.com/bt/download>.

Notes

Mounting

When mounting the device, attach the baseplate first. Then, make the electrical connections, and fit and secure the device (refer to the separated mounting instructions A6V10974417). Mount the device on a flat wall and in compliance with local regulations.

If the reference room contains thermostatic radiator valves, set them to their fully open position.

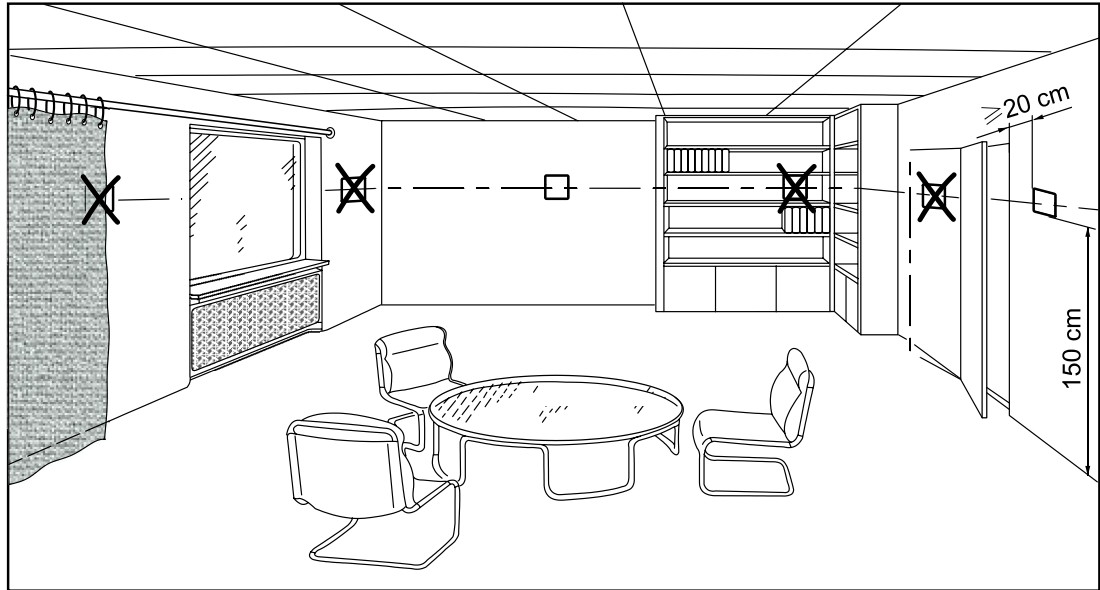

2261703

- The devices are suitable for wall mounting.
- Recommended height: 1.5 m above the floor.
- Do not mount the devices in recesses, shelves, behind curtains or doors, or above or near heat sources.
- Avoid direct solar radiation and drafts.
- Seal the conduit box or the installation tube if any, as air currents can affect sensor readings.
- Adhere to allowed ambient conditions.

Installation

	<p>⚠ WARNING</p>
	<p>No internal line protection for supply lines to external consumers. Risk of fire and injury due to short-circuits!</p> <ul style="list-style-type: none"> • Adapt the line diameters as per local regulations to the rated value of the installed overcurrent protection device. • The power supply lines must have an external circuit breaker with a rated current of max. 10 A.

Change of batteries

If the battery symbol appears, the batteries are almost empty and must be replaced.

Reset

To reset, press the reset button on the rear of the device. This resets all individual settings to their default values.

Maintenance

The device is maintenance-free.

Disposal



The device is considered an electronic device for disposal in accordance with the European Guidelines and may not be disposed of as domestic garbage.

- Dispose of the device through channels provided for this purpose.
- Comply with all local and currently applicable laws and regulations.
- Dispose of empty batteries in designated collection points.

Instructions for the replacement of alkaline batteries



⚠ WARNING

Explosion due to fire or short-circuit, even with discharged batteries

Risk of injury due to flying parts

- Prevent the batteries from coming into contact with water.
- Do not recharge batteries.
- Do not damage or disassemble batteries.
- Do not heat batteries over 85°C.



⚠ WARNING

Leakage of electrolyte

Severe burns

- Handle damaged batteries only wearing suitable protective gloves.
- In case of contact with electrolyte, rinse eyes immediately with plenty of water. Consult a doctor.

Observe the following:

- Use only a battery of the same type and from the same manufacturer as a replacement.
- Observe the polarities (+/-).
- The batteries must be new and undamaged.
- Do not mix new and used batteries.
- Store, transport and dispose of the batteries in compliance with local requirements, regulations and laws. Also observe the instructions of the battery manufacturer.

Technical data

Power supply

Operating voltage	DC 3 V (2 x 1.5 V AA alkaline batteries)
Battery life	>1 year (with AA alkaline batteries)

Internal sensor inputs

Thermistor	10 kΩ ± 1% at 25 °C
------------	---------------------

Switching outputs (Lx, L1, L2)		
Relay contacts	Switching voltage	Max. AC 250 V Min. AC 24 V
	Switching current	Max. 5 A res., 2 A ind.
	At AC 250 V	Min. 8 mA
Insulating strength	Between relay contacts and coil	AC 3,750 V
	Between relay contacts (same pole)	AC 1,000 V



⚠ WARNING

No internal fuse

External preliminary protection with max. C 10 A circuit breaker in the supply line required under all circumstances.

Operational data		
PID control:	Slow	Fast
Minimum period	4 min	2 min
Minimum pulse length	12 min	6 min
RDH100		
Setpoint setting range	5...30 °C	
Factory setting comfort setpoint	20 °C	
RDH100/SPL		
Setpoint setting range	15...30 °C	
Factory setting comfort setpoint	20 °C	
Resolution of settings and displays	Temperature setpoint	0.5 °C
	Display of actual temperature value	0.5 °C

Electrical connections	
Connections terminals (via baseplate)	Screw terminals
For solid wires	2 x 1.5 mm ²
For stranded wires	1 x 2.5 mm ² (min. 0.5 mm ²)

Environmental conditions	
Operation	IEC 60721-3-3
Climatic conditions	Class 3K5
Temperature	0...+40 °C
Humidity	<90% r.h.
Transport	IEC 60721-3-2
Climatic conditions	Class 2K3
Temperature	-25...+60 °C
Humidity	<95% r.h.
Mechanical conditions	Class 2M2
Storage	IEC 60721-3-1
Climatic conditions	Class 1K3
Temperature	-10...+60 °C
Humidity	<90% r.h.

Standards, directives and approvals	
EU conformity (CE)	A6V101123363 *)
RCM conformity	A6V11161600 *)
Safety class	II as per EN 60730-1
Pollution degree	2
Degree of protection of housing	IP20
Eco design and labeling directives	Based on EU Regulation 813/2013 (Eco design directive) and 811/2013 (Labeling directive) concerning space heaters, the following classes apply: Application with On/Off operation of a heater Class I Value 1% PWM (TPI) room thermostat, for use with On/Off output heaters Class IV Value 2%
Environmental compatibility	The product environmental declaration (A6V101123358 *) contains data on environmentally compatible product design and assessments (RoHS compliance, materials composition, packaging, environmental benefit, disposal).

*) The documents can be downloaded from <http://siemens.com/bt/download>.

General	
Weight (including package)	350 g
Color of housing front	Signal-white RAL9003
Housing material	ABS (LCD lens:PC)

Connection diagram

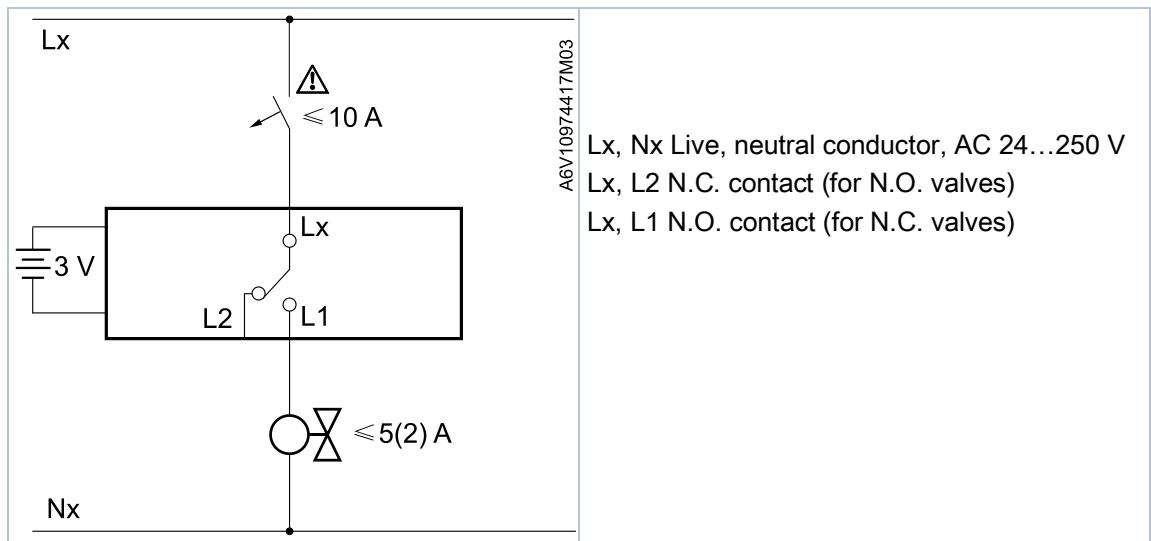

Application examples

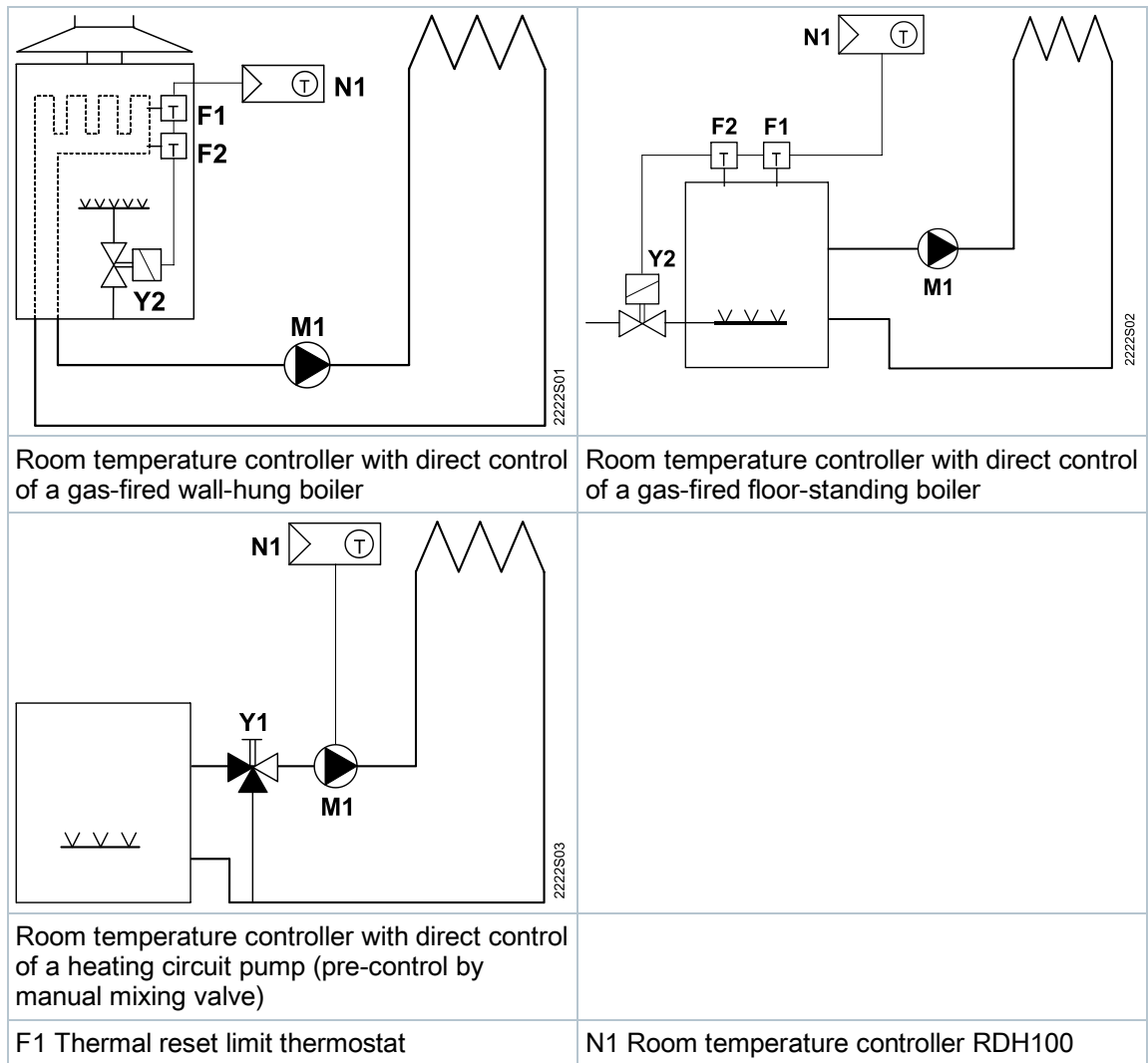

F2 Safety limit thermostat M1 Circulating pump	Y1 3-port valve with manual adjustment Y2 Magnetic valve
---	---

Dimensions

[mm]

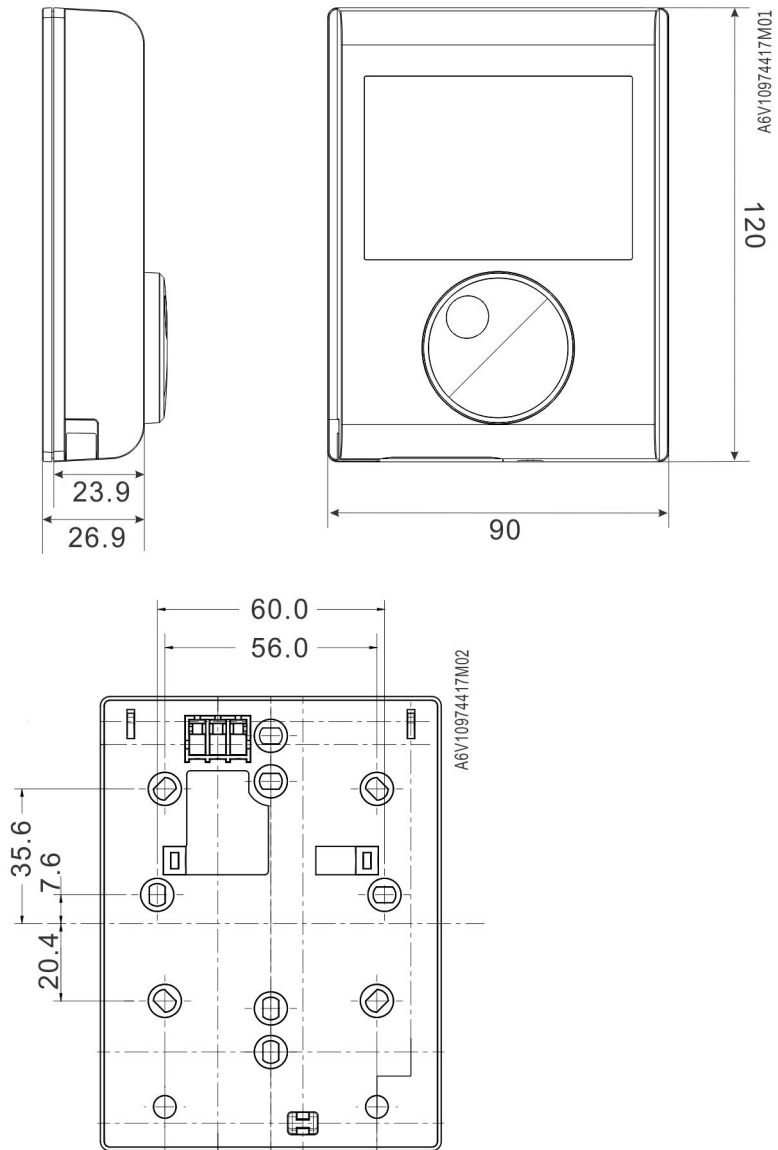

Product history

Index ¹⁾	Date	Changes
≥C	June 2018	<ul style="list-style-type: none">• Add new function min/max temperature limitation, selectable control behavior and parameter settings.
Z, A	March 2017	First release.

1) Product index can be found next to the production date on the rear of the device, "YYMMDDX".